



L-14x120-B465-W-DIF-S
Diffused homogeny LED line light
for industrial image processing



Made in GERMANY © evotron 2019-02

Functional Overview

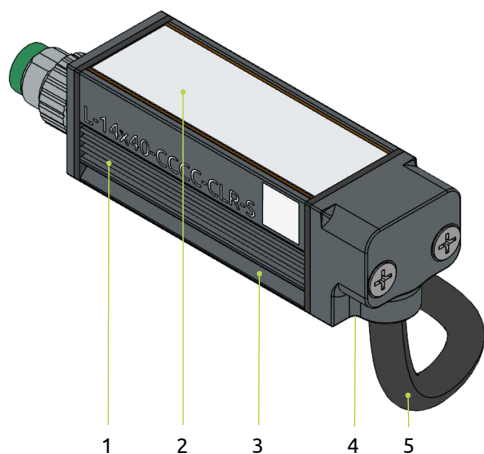

- 1 Housing
- 2 Glass cover, light field
- 3 Mounting groove - dovetail
- 4 Profile groove - M3 hexagon screws
- 5 Robotics connection cable with M8 plug

Dimensions

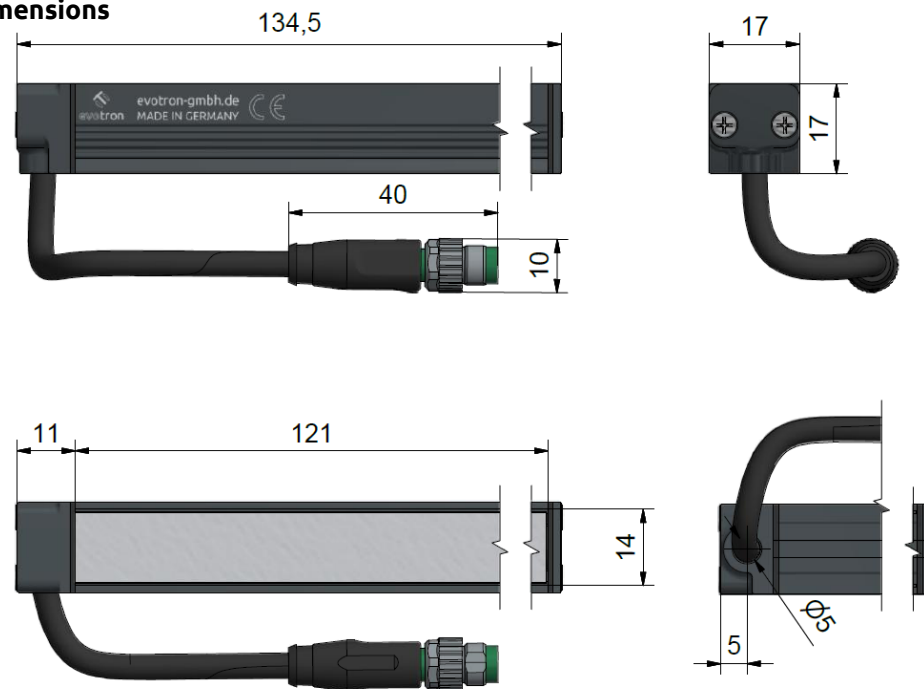

Cable length without connector = 200 mm

All dimensions in mm

Connection plan

The LED lighting must be controlled with a suitable constant current source!

Suitable for operation are evotronLIGHT lighting controllers or other commercially available LED controllers with a regulated current output. (see technical data)

Pin Assignment M8 male 4-pin

	PIN 1	brown	+LED
	PIN 2	white	SD *
	PIN 3	blue	-LED
	PIN 4	black	SG *

* this pins only use for LED-Lightings with evotronLIGHT-Technology

IMPORTANT NOTICE

Do not connect the LED lighting directly to a 24V power source or to any power supply.

Technical Data

LED-Colour, Wavelength	Blue, 465 nm		
Radiation Angle	diffused light		
Optical Material	Glass		
Dimension Light Field (B x L)	14 mm x 121 mm		
Dimension Housing (H x B x L)	17 mm x 17 mm x 134.5 mm		
Housing Material	Aluminium / PA12		
Weight	69 g		
Protection Rating	IP 67		
Protection Class	III, Safety Extra Low Voltage (SELV)		
Risk Group (DIN EN 62471)	Free Group		
Thermal Protection T _{MAX}	85 °C		
Plug type	M8-male, 4-pin		
Continuous Operation	Min	Nom	Max
LED-Current	0 A	180 mA	180 mA
LED-Forward Voltage	-	11.6 V	17.8 V
Power Consumption	0 W	2.1 W	3.2 W
Flash Mode	Min	Nom	Max
LED-Current	0 A	-	1.8 A
LED-Forward Voltage	-	-	22.0 V
Power Consumption @ Pulse (t _{PULSE} 300 µs)	0 W	-	39.6 W



evotron GmbH & Co. KG
Pfüttschbergstraße 16
98527 Suhl /Germany

+49 (0) 3681-4529950
info@evotron-gmbh.de
www.evotron-gmbh.de

Intended Use

This LED lighting is intended solely for use in the field of industrial automation technology, laboratory metrology and industrial image processing.

The permissible ambient conditions for the transport, assembly and operation of the module must be observed.



Safety Notes

Operate this LED line light only in perfect, undamaged condition.

Configure the application so that the LED lighting is always within its technical specification.

Improper installation can damage the LED lighting.

Installation, assembly and commissioning must be carried out by qualified personnel.



Risk of injury from flickering, glare or radiation

Flickering, glare and stroboscopic effects can cause psychological disorders such as headache, discomfort or fatigue.



Risk of glare

A strong glare effect may cause a temporary reduction in eyesight, which may cause irritations or accidents.



Risk of burns due to hot surfaces

The lighting surface can reach a housing temperature of $> 55\text{ }^{\circ}\text{C}$ during operation. Do not cover or touch the lightings during operation.

Mounting with Swivel Mount (accessories)

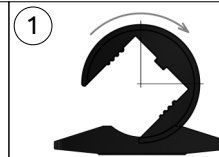

2

Attach the swivel mount to the profile groove

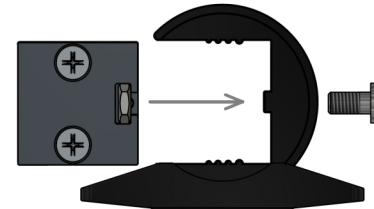

2x nuts M3 (ISO 4035) / 2x screws M3 x 6mm (ISO 4762)

3

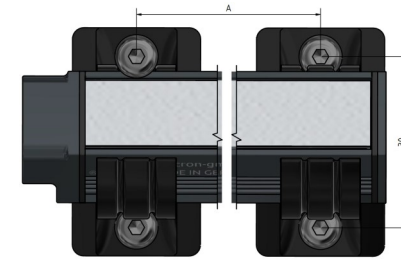

$A = l_{\text{Light_field}} - 18\text{mm}$ 4 x screws M4 (ISO 7380-2)

Mounting by using the mounting groove for M3 screws

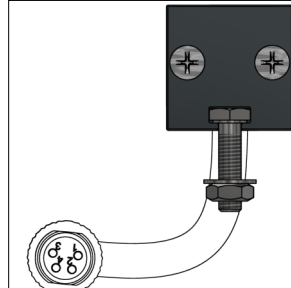
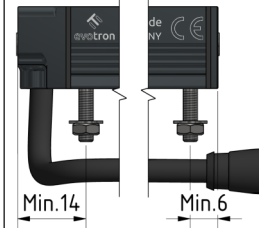

Version 1:
Insert M3 hex bolts into the profile groove and fasten with M3 nut

Version 2:
Insert flat M3 nuts (ISO 4035) into the profile groove.

screw depth 3,2 mm

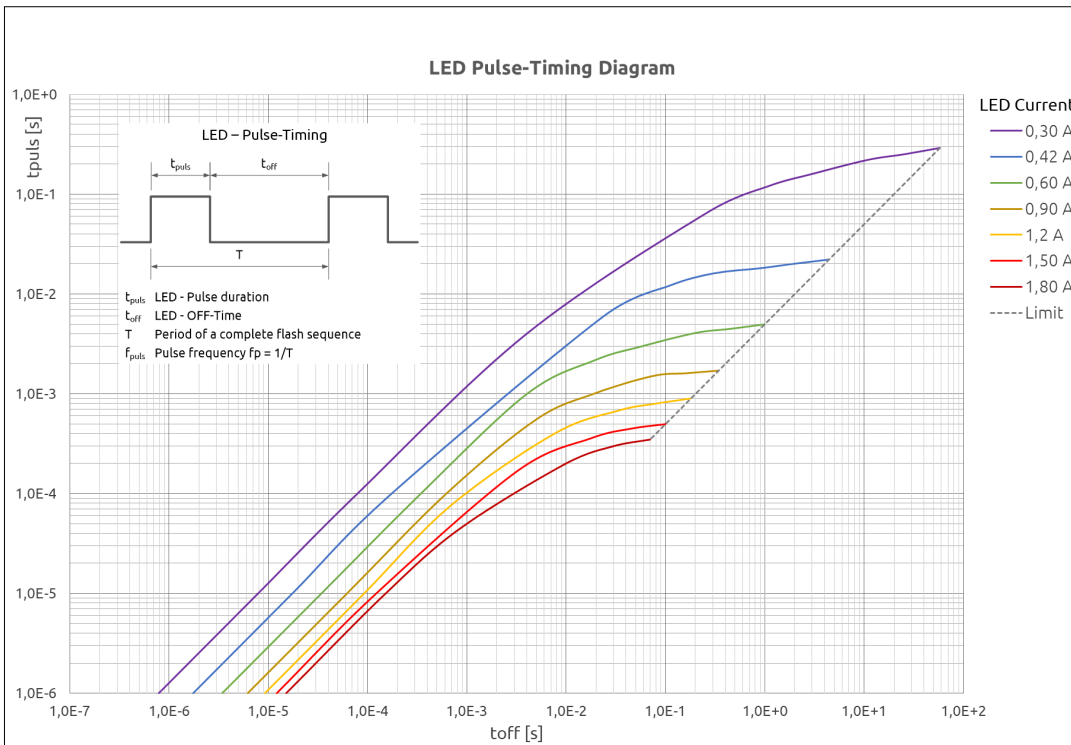
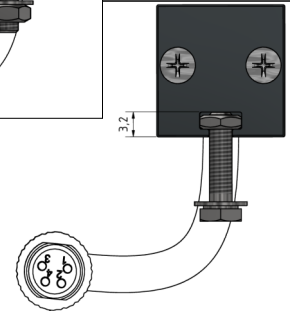

Putting into operation

Operate the LED lighting exclusively with the parameters specified under the item Technical data.

For the flash mode, you can read off the required minimum OFF-time t_{off} directly from the pulse timing diagram depending on the selected LED flash current and the desired flash duration t_{puls} .

The LED lighting is intended for use with a suitable LED constant current source.

Cleaning

You can clean the outside of the lighting with a damp cloth. For the glass surface use a cleaner that is suitable for optical components.

Make sure that your cleaning solvent is approved for the material used.

Technical Support

Questions concerning our products will be answered by our technical support:

support@evotron-gmbh.de

+49 (0) 3681 / 4529951

Disposal

This product is RoHS compliant.

Instructions for the proper disposal of old devices can be obtained from the manufacturer, local sales partner or relevant national authority.

Alternatively, this product may be returned to the manufacturer for proper disposal.

Packaging and packaging aids are recyclable and should always be recycled.

The product itself must not be disposed of in the domestic waste.



WEEE-Reg.-Nr. DE85473784